

LH-6204				
Typ	Di	H	dL	t
LH-63,5x1,75/6204	60,5	33	26	1,5
LH-80x2,0/6204	76,5	36,5	26	2,0
LH-80x3,0/6204	74,5	36,5	26	2,0
LH-89x3,0/6204	83,5	36,5	26	2,0
LH-108x2,5/6204	103,3	36,5	26	2,0
LH-108x3,25/6204	102,1	36,5	26	2,0
LH-133x3,6/6204	126,3	36,5	26	2,5

G Materiał: stal węglowa



LH-6204



D [mm]
63,5 - 133

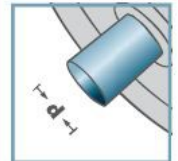

d [mm]
20



C [daN]
-

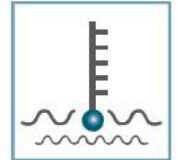

T [°C]
-



6204:
D47, d20, H14



Gitterbox [Stck.]

ø63,5: 6000
ø80: 3500
ø89: 3100
ø108: 2100
ø133: 1150

LH/FL

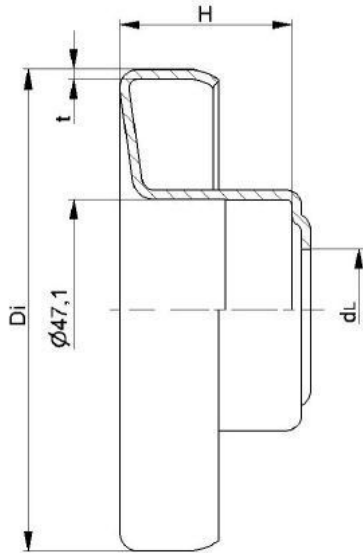

LH-6204 N

Typ	Di	H	dL	t
LH-63,5x1,75/6204N	60,5	31,8	21	1,5
LH-89x3,0/6204N *	83,7	33,5	21	1,5
LH-108x3,25/6204N	102,1	36,5	21	2,0

Materiał: stal węglowa
N* - stal nierdzewna



LH-6204 N

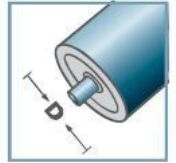

D [mm]
63,5 - 108

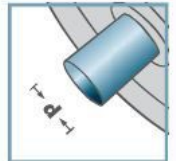

d [mm]
20



C [daN]
-

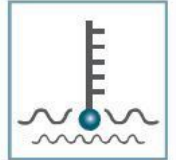

T [°C]
-



6204:
D47, d20, H14



Gitterbox [Stck.]

ø63,5: 6000
ø89: 3100
ø108: 2100

LH/FL

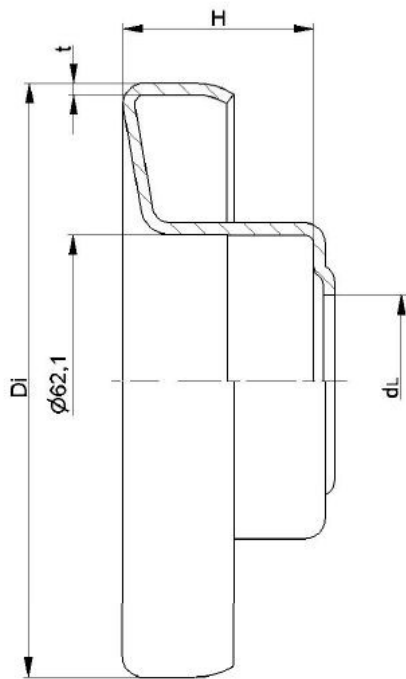

LH-6305				
Typ	Di	H	dL	t
LH-89x3,0/6305	83,5	40,5	36,5	2,0
LH-108x2,5/6305	103,3	40,5	36,5	2,0
LH-108x3,25/6305	102,1	40,5	36,5	2,0
LH-133x3,6/6305	126,3	40,5	36,5	2,5
LH-159x4,5/6305	150,5	40,5	36,5	2,5

Materiał: stal węglowa



LH-6305

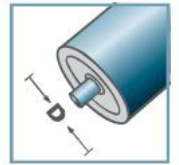

D [mm]
89 - 159

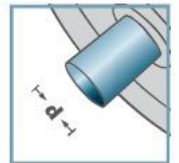

d [mm]
25



C [daN]
-

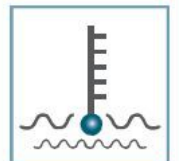

T [°C]
-



6305:
D62, d25, H17



Gitterbox [Stk.]

ø89: 2600
ø108: 1900
ø133: 1150

LH/FL

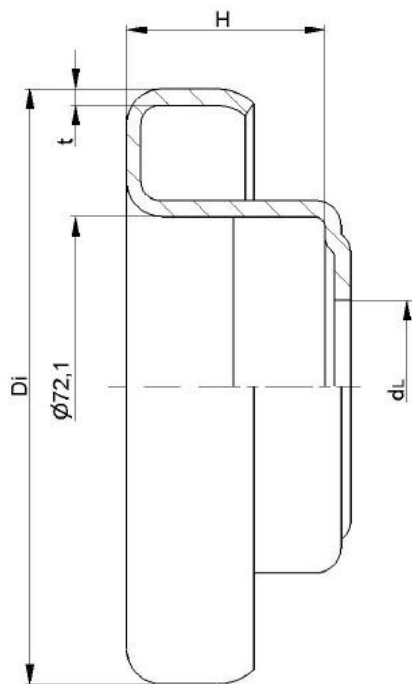

LH-6306				
Typ	Di	H	dL	t
LH-108x3,25/6306	102,1	42	36,5	3,0
LH-133x3,6/6306	126,3	42	36,5	3,5
LH-159x4,5/6306	150,5	42	36,5	2,5

Materiał: stal węglowa



LH-6306



D [mm]
108 - 159

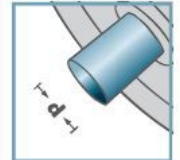

d [mm]
30



C [daN]
-

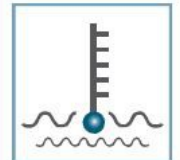

T [°C]
-



6306:
D72, d30, H19



Gitterbox [Stck.]

ø108: 1700
ø133: 1000

LH/FL

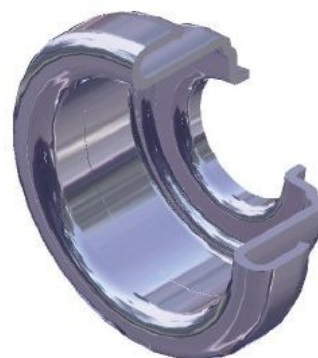
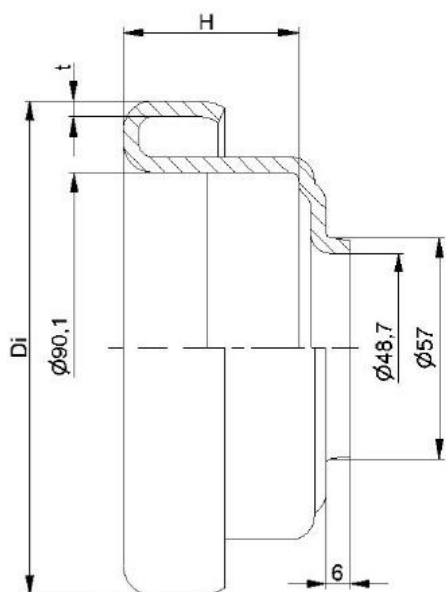

LH-6308

Typ	Di	H	t
LH-133x3,6/6308	126,3	44,6	4,0
LH-159x4,5/6308	150,8	44,6	4,0

Materiał: stal węglowa



LH-6308



D [mm]
133 - 159

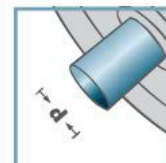

d [mm]
40



C [daN]
-

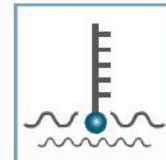

T [°C]
-



6308:
D90, d40, H23



Gitterbox [Stck.]

ø133: 800
ø159: 600

LH/FL

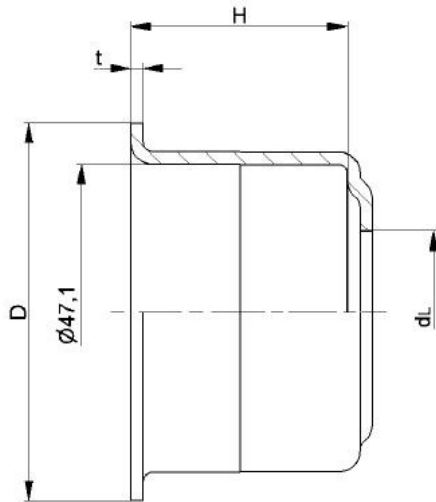

FL-6204

Typ	D	H	dL	t
FL-60x3,0/6204	58,1	34	26	2,0
FL-63,5x2,9/6204	60,0	34,5	26	2,0
FL-76/6204	73,5	34,5	26	2,0

Materiał: stal węglowa



FL-6204



D [mm]
60 - 76

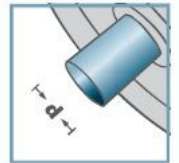

d [mm]
20



C [daN]
-

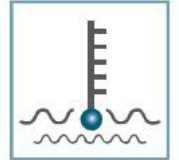

T [°C]
-



6204:
D47, d20, H14



Gitterbox [Stek.]

ø60: 4000
ø63,5: 4000
ø70: 2000
ø76: 2000

LH/FL

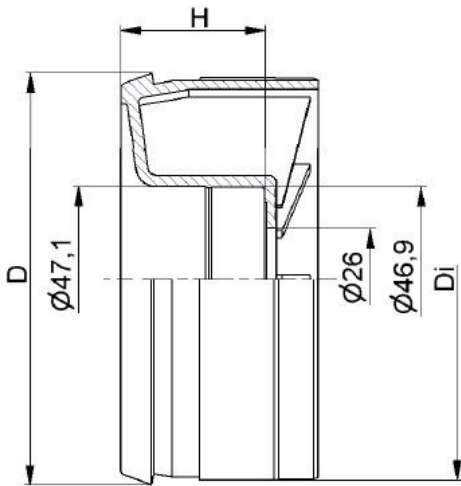

KLH-6204

Typ	Di	H	D
KLH-89x3,0/6204	83,2	36,5	85,3
KLH-108x3,0/6204	102,2	36,5	104,3

Materiał: tworzywo sztuczne



KLH-6204

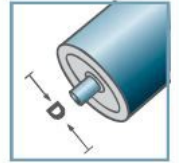

D [mm]
89 - 108

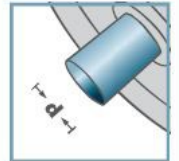

d [mm]
20



C [daN]
-

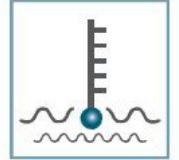

T [°C]
100°



6204:
D47, d20, H14



Gitterbox [Stk.]

1000

LH/FL

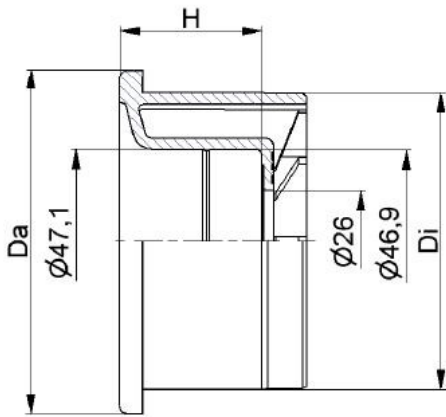

KLH-6204

Typ	Da	Di	H
KLH-90x7,0/6204	88,8	76,3	36,5

Materiał: tworzywo sztuczne

KLH-6204



D [mm]
90

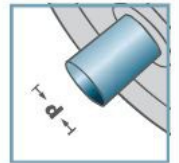

d [mm]
20



C [daN]
-

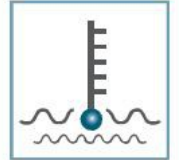

T [°C]
100°



6204:
D47, d20, H14



Gitterbox [Stek.]

ø60: 4000
ø63,5: 4000
ø70: 2000
ø76: 2000



LH/FL

USZCZELNIENIE LABIRYNTOWE

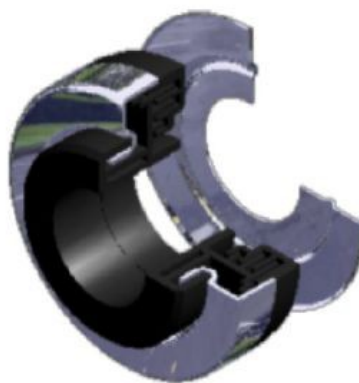
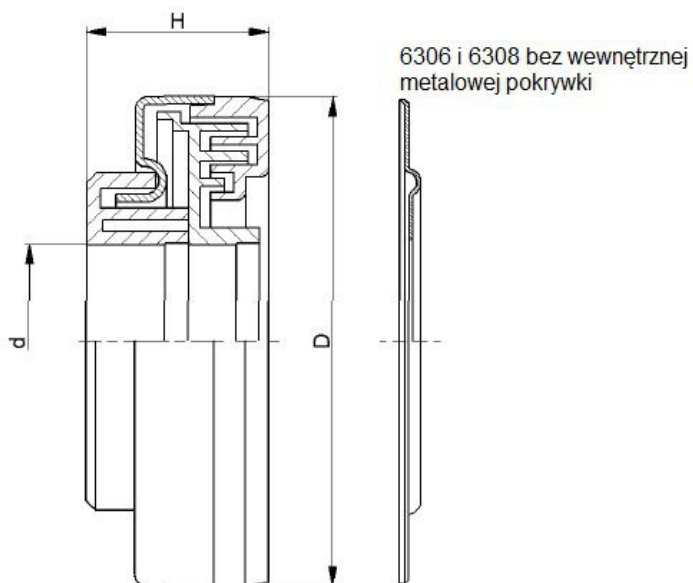

LH-			
Typ	D	H	d
LH-6303	47	22,5	17
LH-6204	47	22,5	20
LH-6204 N *	47	20,0	20
LH-6305	62	23,5	25
LH-6206	62	23,5	30
LH-6306	72	24,5	30
LH-6308	90	23,1	40

Materiał: stal ocynkowana + tworzywo sztuczne
6204 N* elementy stalowe ze stali nierdzewnej



LH-



D [mm]

-

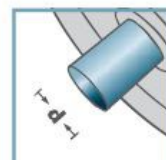
d [mm]
17 - 40

C [daN]

-

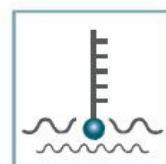
T [°C]
0° - 80°

-



Karton [Stek.]

6204: 500
6305: 500

LH/FL

USZCZELNIENIE LABIRYNTOWE ZE SMAREM

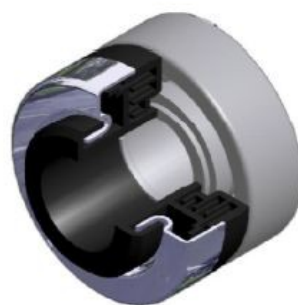
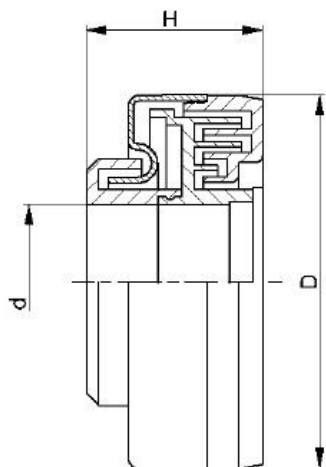

Typ	D	H	d
LH-6303 M	47	22,5	17
LH-6204 M	47	22,5	20
LH-6305 M	62	23,5	25
LH-6308 M	90	23,1	40

Materiał: stal ocynkowana + tworzywo sztuczne
Smar: EP2



LH-



D [mm]

-

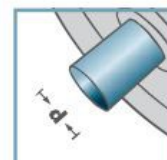

d [mm]

17, 20



C [daN]

-

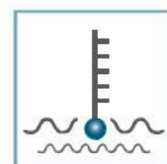

T [°C]

0° - 80°



-



Karton [Stok.]



LH/FL

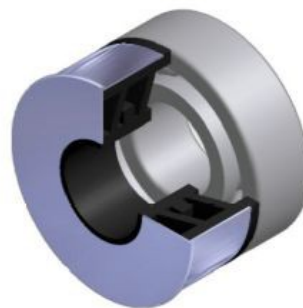
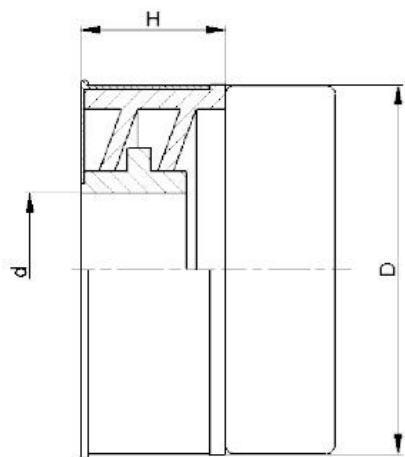

UF-			
Typ	D	H	d
UF-6204	47	18,5	20

Materiał: stal ocynkowana + tworzywo sztuczne



UF-

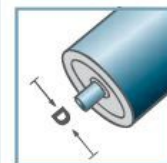

D [mm]

-

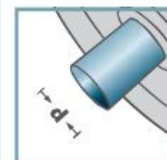

d [mm]
20



C [daN]

-

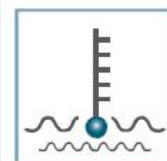

T [°C]
0° - 80°



-



Karton [Stek.]



LH/FL

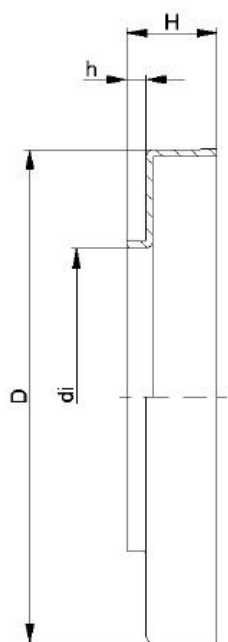

ST-				
Typ	D	d_i	H	h
ST-6204	47,5	27,4	11,9	2,4
ST-6305	62,5	37,4	11,4	2,4
ST-6306	72,5	37,4	11,4	1,4

Materiál: stal



ST-



D [mm]

-

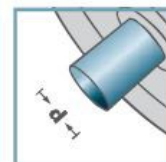

d [mm]

-



C [daN]

-

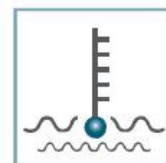

T [°C]

-



-



Karton [Stok.]



LH/FL

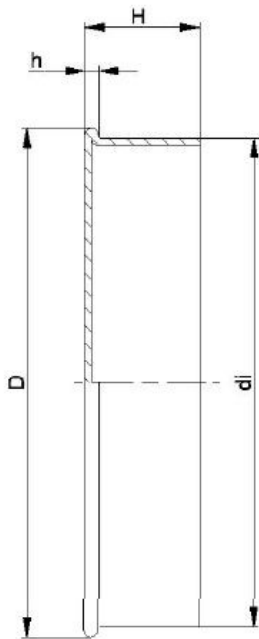

ST- geschlossen				
Typ	D	di	H	h
ST-6204	50	47,4	14,7	1,8
ST-6305	65	62,4	14,7	1,8
ST-6306	77	72,4	12,5	1,8

Materiál: stal



ST- G



D [mm]

-

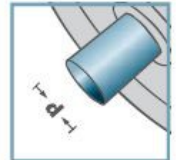

d [mm]

-



C [daN]

-

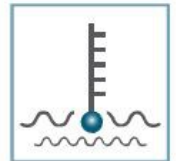

T [°C]

-



-



Karton [Stck.]

ST-6204 125
ST-6305 100
ST-6306 100

LH/FL

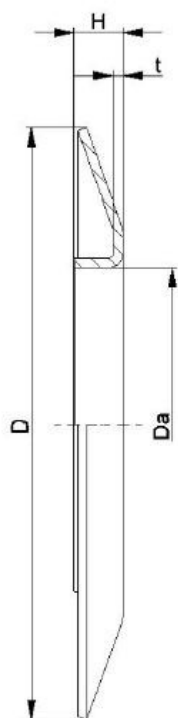

BS-				
Typ	Da ±0.1	D -2	H ±0.5	t
BS-50-130	49,9	130	10	1,5
BS-60-130	59,9	130	10	1,5
BS-80-150	79,9	150	14	2,5
BS-89-150	88,9	150	14	2,5
BS-108-150	107,9	150	14	2,5

Materiał: stal



BS-



D [mm]

-

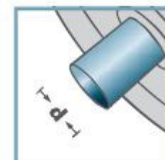

d [mm]

-



C [daN]

-

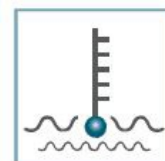

T [°C]

-



-



Karton [Stok.]